



CHARLES A. TEMPLETON MACHINE INC.

2727 N. Golder Avenue ☽ Odessa, TX 79764
 Phone: (432) 332-0359 ☽ Fax (432) 332-0412
 E-mail: info@catmachinc.com

TEMPLETON Part	Page No.
☽ Soft Set Releasing & Pulling Tool	2.....
☽ Arresting Device ☽ Anti Blow-Up Tool	3.....
☽ Tandem Knuckle Sub.....	4.....
☽ Safety Shear Sub.....	4.....
☽ Four-Blade Nogo.....	5.....
☽ BHP Shock Absorber	6.....
☽ Tubing Arresting Stop	7.....
☽ BHP Bomb Centralizer	7.....
☽ One Inch Coil Tubing Overshot	8.....
☽ Baker Lock Internal Pulling Tool	8.....
☽ Overshot ☽ Type Pulling Tool.....	9.....
☽ Wireline Grab	9.....
☽ Kobe Taper Seat Standing Valve Pulling Tool.....	10.....
☽ ØVÓ Plug Slip-Type Mandrel	11.....
☽ Removable Pump Seating Nipple Assembly (T&C Tubing).....	12.....
☽ Removable Pump Seating Nipple Assembly (IJ Tubing).....	13.....
☽ C.A.T. Tubing Stop	14.....
☽ Templeton Test Plug (T&C Tubing).....	15.....
☽ Templeton Locator Assembly (Equalizing)	16.....
☽ Templeton Locator Assembly (T&C Tubing).....	17.....
☽ Templeton Locator Assembly (IJ Tubing).....	18.....
☽ Templeton Locator Assembly (IJ Tubing).....	19.....
☽ Templeton Test Plug (Seating Nipple).....	20.....
☽ Segmented Pineapple Tubing Broaches	21.....
☽ Pineapple Descaler Broach	22.....
☽ Pineapple Swaging Broach.....	23.....
☽ Pineapple Swaging Broach (Long Style)	24.....
☽ Runger Pulling Tool	25.....

*All information, illustrations, and photographs in this publication
 are the property of Charles A. Templeton Machine Inc.
 No part of this publication may be copied, reproduced, or used for any other
 purpose without the written consent of Charles A. Templeton Machine Inc.*

Revised 9/04

Soft Set Releasing & Pulling Tool

A Better Approach to Soft Set Releasing & Pulling PHP Equipment

From Charles A. Templeton

The Templeton releasing and pulling tool permits a bottom-hold pressure bomb or other tool to be released from a running tool string without jars or shearing pins where the bomb is to be set on a nogo, stop, or hung in a nipple.

With this tool assembly, the bomb may be retrieved without returning to the surface.

A special running and pulling J (fishing neck) is attached to the tool to be released. The running and pulling tool includes a hydraulic dampener assembly to prevent a premature release in case the tool sets down on a shoulder or an obstruction down hole.

The dampener assembly does not stop the release; it merely slows it down. If the tool sets down and release is started, there is time to pick up the string and recover before a release is completed. The dampener will return to its beginning position.

Fifty pounds is required to release the fishing neck, when the complete assembly is used. A spring in the skirt may be omitted reducing the weight to thirty pounds, if desired.

This tool assembly has been tested and proven by years of service.

Patented



Arresting Device – Anti Blow-Up Tool

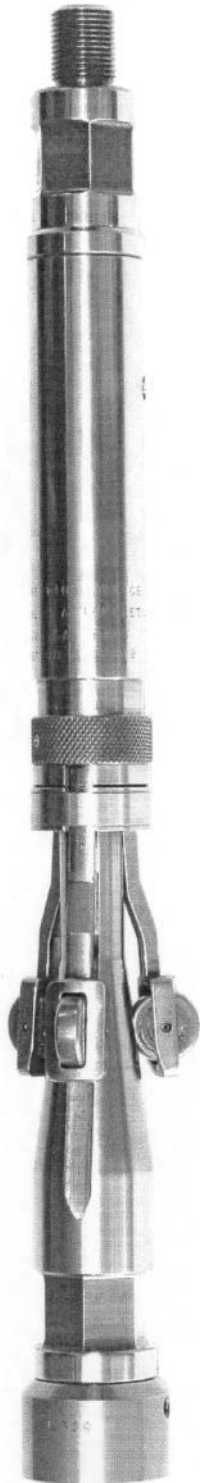

A New Concept

An Arresting Device – Anti Blow-Up Tool

Instead of the conventional slips or finger-type barbs, this tool employs rollers over a tapered mandrel to engage the tubing wall.

In the case of a blow-up or upward motion of the tapered section of the mandrel, the rollers are held by arms attached to the barrel allowing the mandrel to expand the rollers and **roll** into the tubing wall.

The same action occurs in cases such as a plug, bomb or other tool that is located in a nipple or on a stop and the arresting device is positioned on top to prevent the tool from coming up the hole.

The upper sub is threaded to receive a rope socket, fishing neck, stem, etc. (3/4-16 thd.)

The lower end of the tapered mandrel is threaded internally to receive a tool string (3/4-16 thd.). It is also threaded externally to receive various O.D. sizes of skirt to be determined by the size of the tubing in which it is to be used. The skirts determine the effective area of the tapered mandrel.

A spring may be used in the upper barrel. The weight of the tool string below should offset the spring, in running position. When the string is set down on a stop or nogo, the rollers are then pushed down on the tapered mandrel and engage the tubing wall.

The device is retrievable by simply pulling up. It is not necessary to use jars to set or retrieve the device.

The major O.D. of the device is 1 7/16 in. All components are made from heat-treated stainless steel. Variations in upper and lower threads may be made at the time of manufacture to suit your needs. Separate arms, rollers, and skirts are available for different tubing sizes.

Patented

Tandem Knuckle Sub

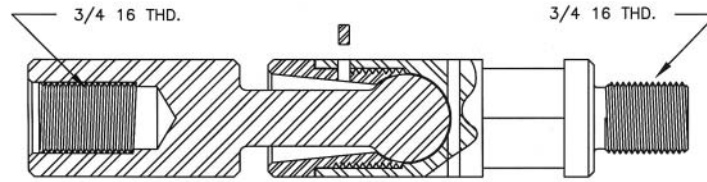

BETWEEN TOOL STRING AND BOMBS
TKS U

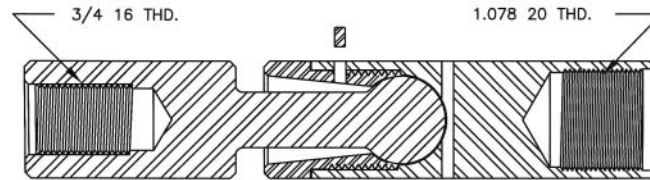

BETWEEN BOMBS
TKS L

FOR 1 1/4 B.H.P. BOMB
DEVIATION: 5°
SWIVEL JOINT ONLY

Safety Shear Sub

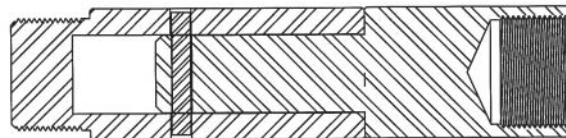
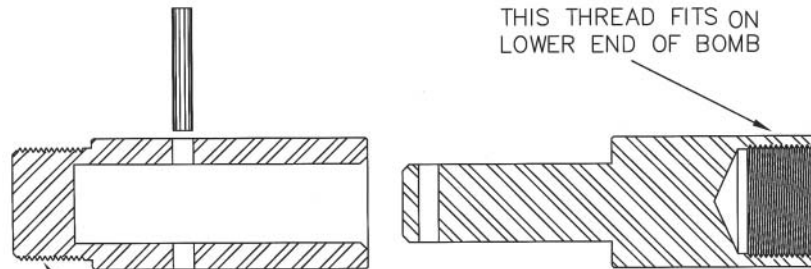

Four-Blade Nogo

Four-Blade Bottom Nogo for BHP Bomb

Body O.D. 1-1/4 with six 1-1/16 Wrench Flats.

Bore for thermometer 5/8 dia. x 5 1/2 deep.

Variations available with upper and lower threads – without thermometer well or with pin and fishing neck or flange.

Common sizes range from 1.850 thru 2.500.

Material: Heat-treated stainless steel.

Flow area past the blades normally exceeds the area between the bomb and tubing.

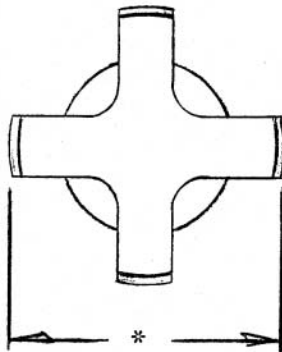
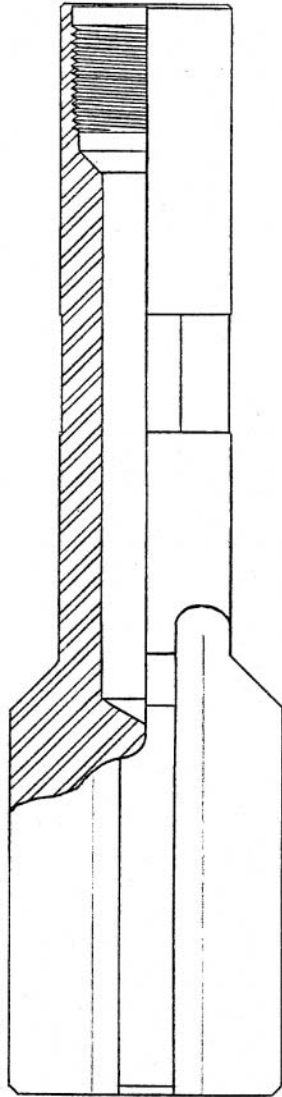

BHP Bomb Shock Absorber (16 1/2 in. O.A. Length Extended)

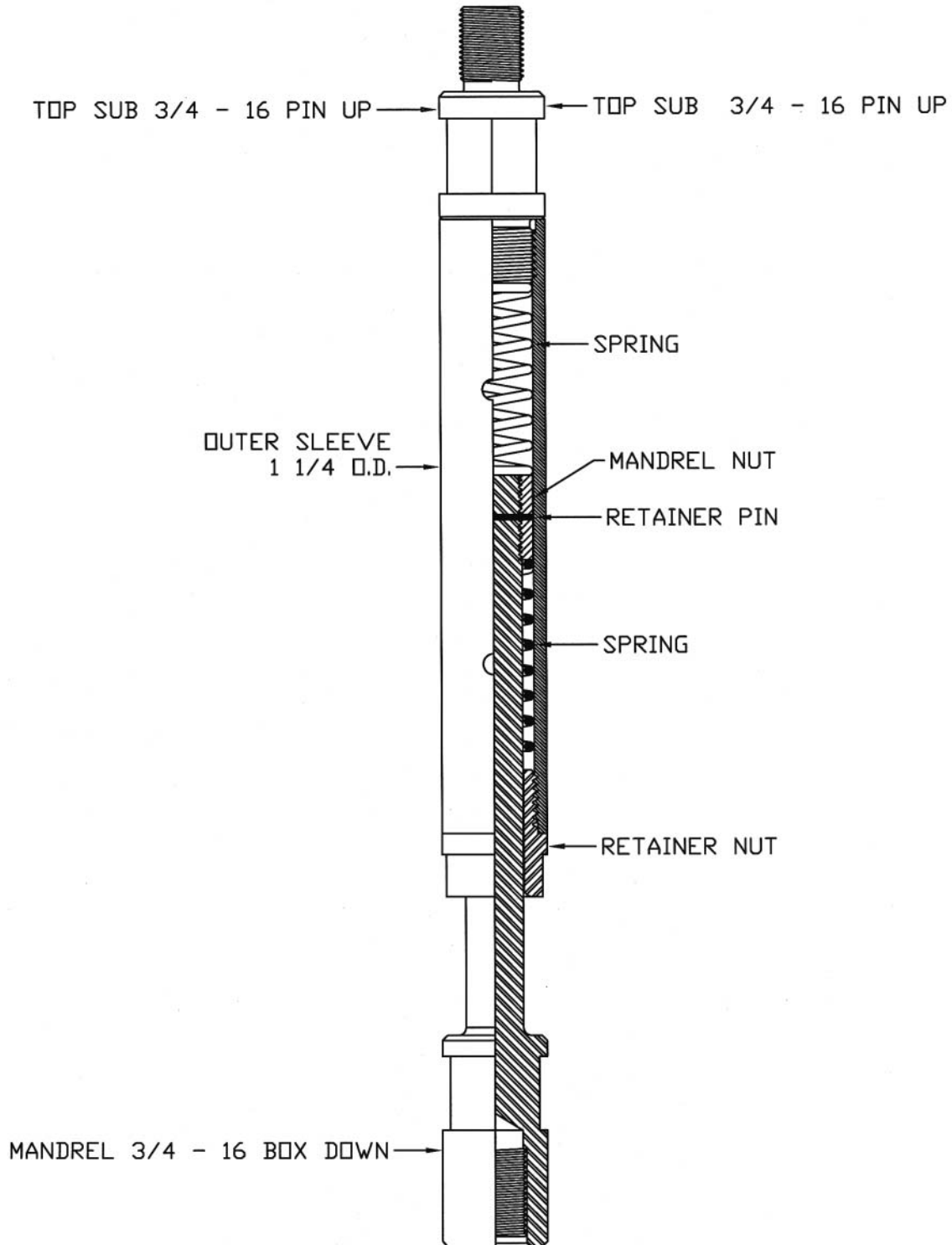

Tubing Arresting Device



Tool Centralizer

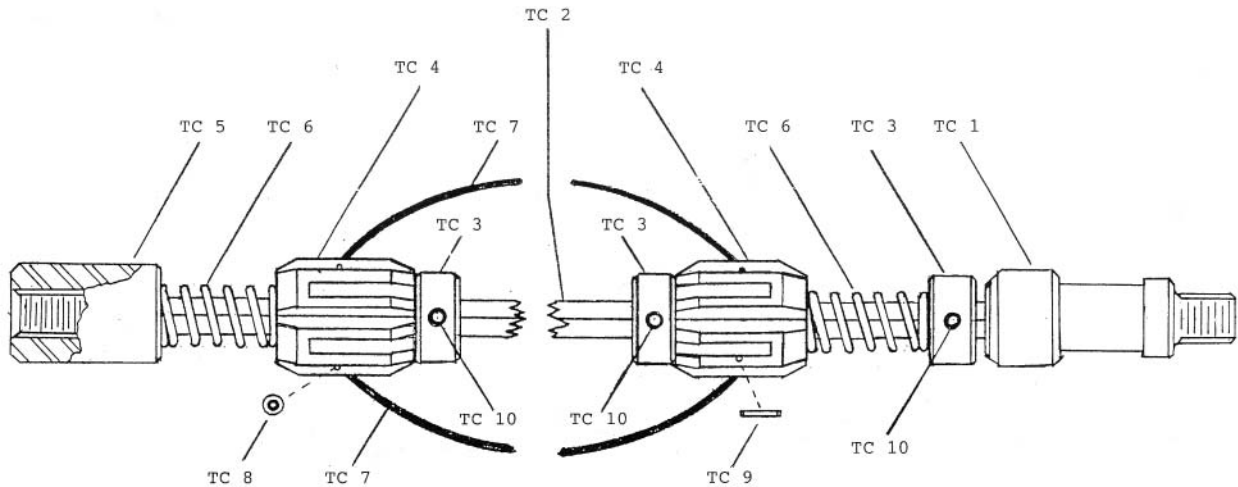

TC 102 Centralizer 9/92

Part No.	Description	No. Pieces Required
TC 1	Upper Adapter Sub (Specify Rod Pin & FN)	1
TC 2	Central Mandrel	1
TC 3	Set Collar	3
TC 4	Bow Spring Carrier	2
TC 5	Lower End Sub (Specify Rod Box)	1
TC 6	Coil Spring (.9 O.D. x .7 I.D. x 3.5 Long)	2
TC 7	Bow Spring	6
TC 8	Bow Spring Eye Sleeve	12
TC 9	5/32 x 3/4 SS Spring Pin	12
TC 10	5/16 - 18 x 3/8 SS Set Screw	6

One Inch Coil Tubing Overshot

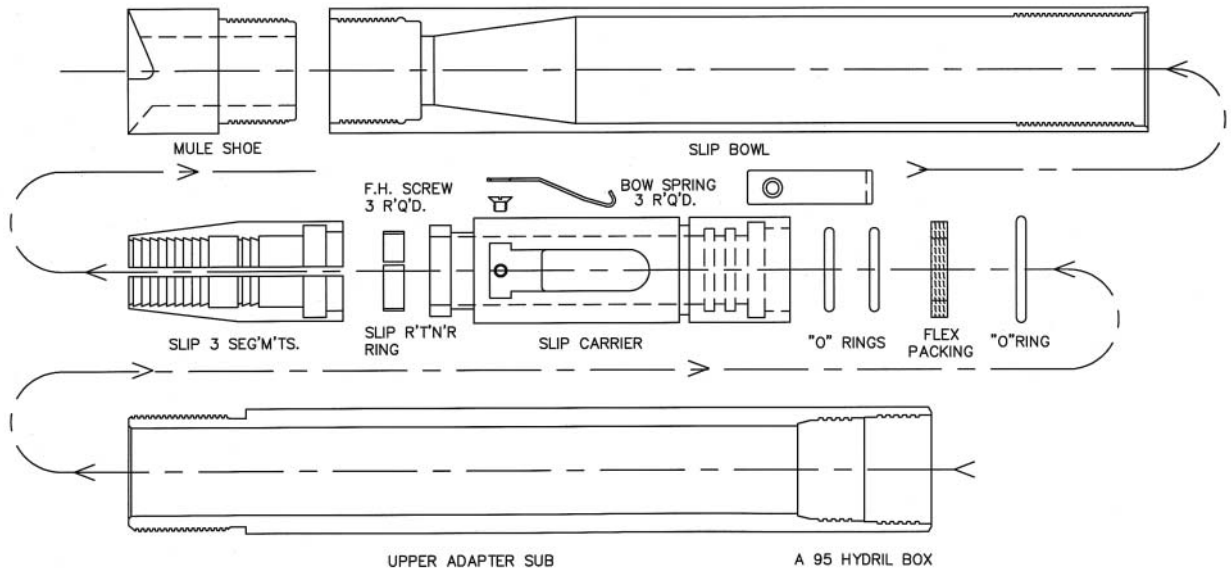

Baker Lock Inside Pulling Tool

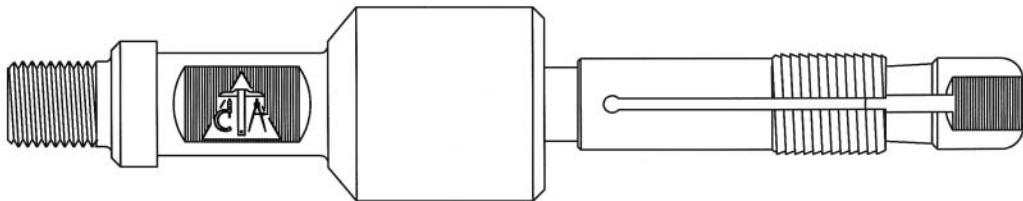

OPTION 1: 5/8 ROD PIN W/ 1 3/8 FISING NECK

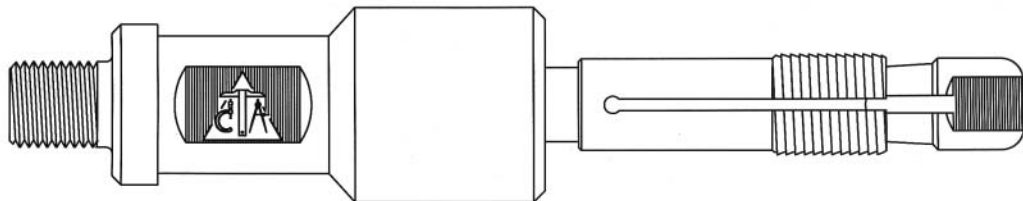

OPTION 2: 5/8 ROD PIN W/ 1 3/4 FISHING NECK

Overshot

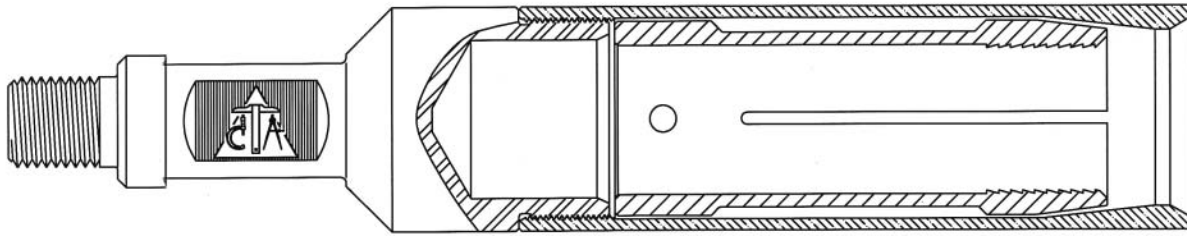

Wire Grab

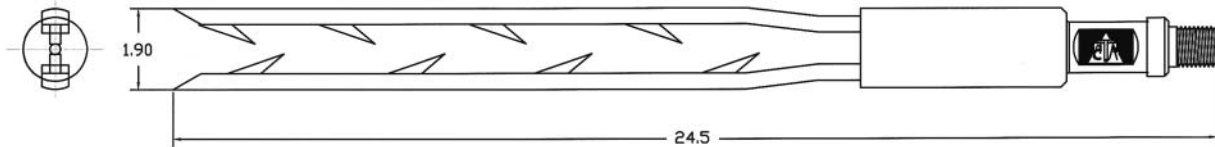

Kobe Taper Seat

Kobe Taper Seat Standing Valve Pulling Tool



This tool consists of a top sub, mandrel, and slip. It is a positive latch-type tool.

The top sub has a 5/8 in. rod pin up (15/16-10) with a 1 3/8 in. Otis Flange fishing neck. It is machined to the same taper as the standing valve seat with two bypass grooves milled along the taper for fluid passage.

The mandrel will allow the slip to rise and collapse when inserting the tool into the valve. It is long enough to knockout the upper knock-out plug of a Kobe valve.

When the upper sub is in the seat, the slip will fall into pulling position as shown and the pulling lips are expanded by the mandrel. If it is apparent the standing valve cannot be pulled; continued stroking will peel the pulling lips off the slip allowing the tool to be withdrawn.

The mandrel and slip are made of heat-treated alloy steel.

Standard sizes are 2 in. for 2 3/8 in. tubing and 2 1/2 in. for 2 7/8 in. tubing. Special sizes and variations can be supplied upon request.

“W” Plug Slip-Type Mandrel

W Mandrel

W Mandrels are designed to lock and pack-off wireline-retrievable flow controls in wells not equipped with landing nipples.

Designed to hold pressure differential from below only, the pack-off element is mechanically expanded with the running tool. It can be used in conjunction with regulators, safety valves, pump-through plugs, and bottom-hole chokes.

This tool is made of heat-treated stainless steel and slips are made of heat-treated alloy steel.



Removable Pump Seating Nipple Assembly (T&C Tubing)

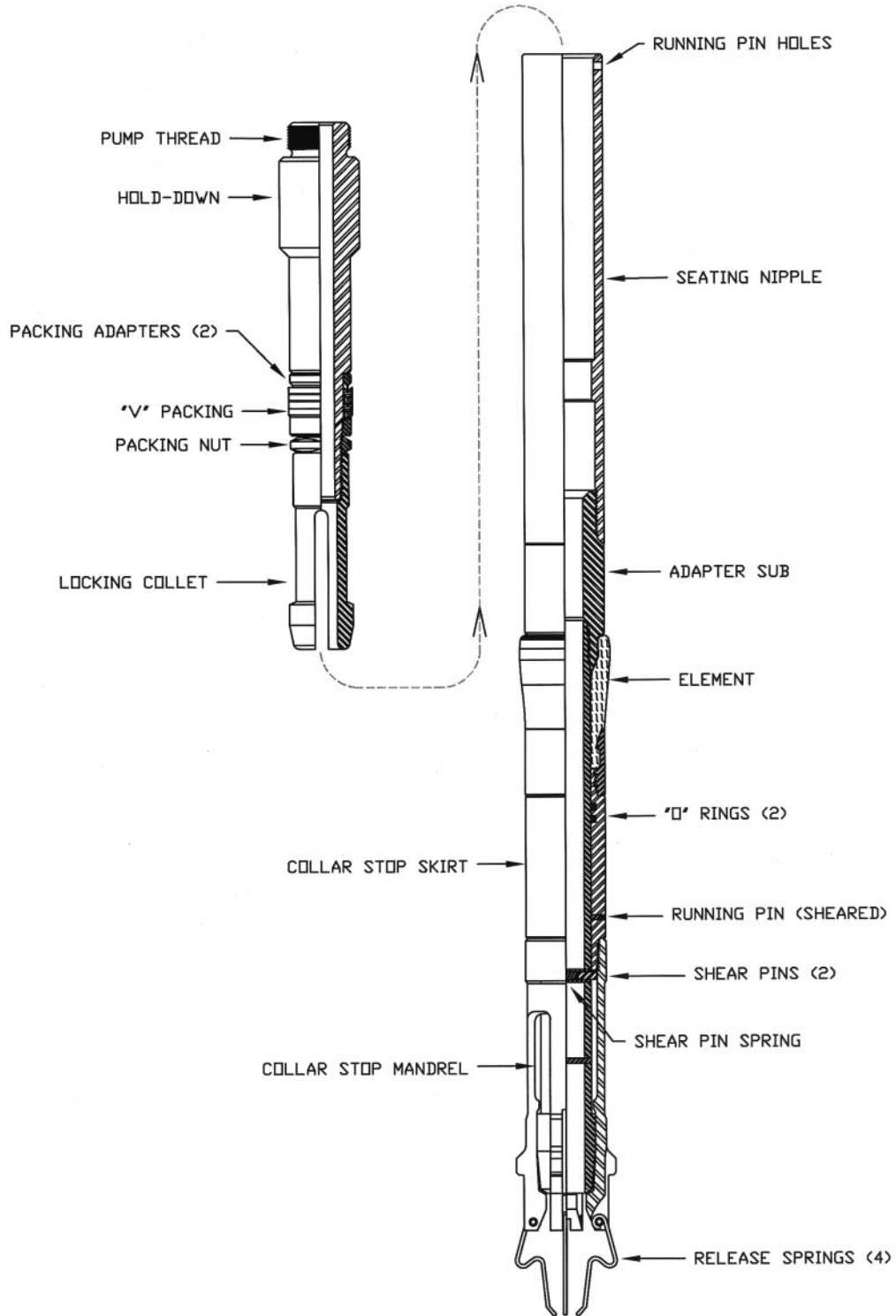

Removable Pump Seating Nipple Assembly (IJ Tubing)

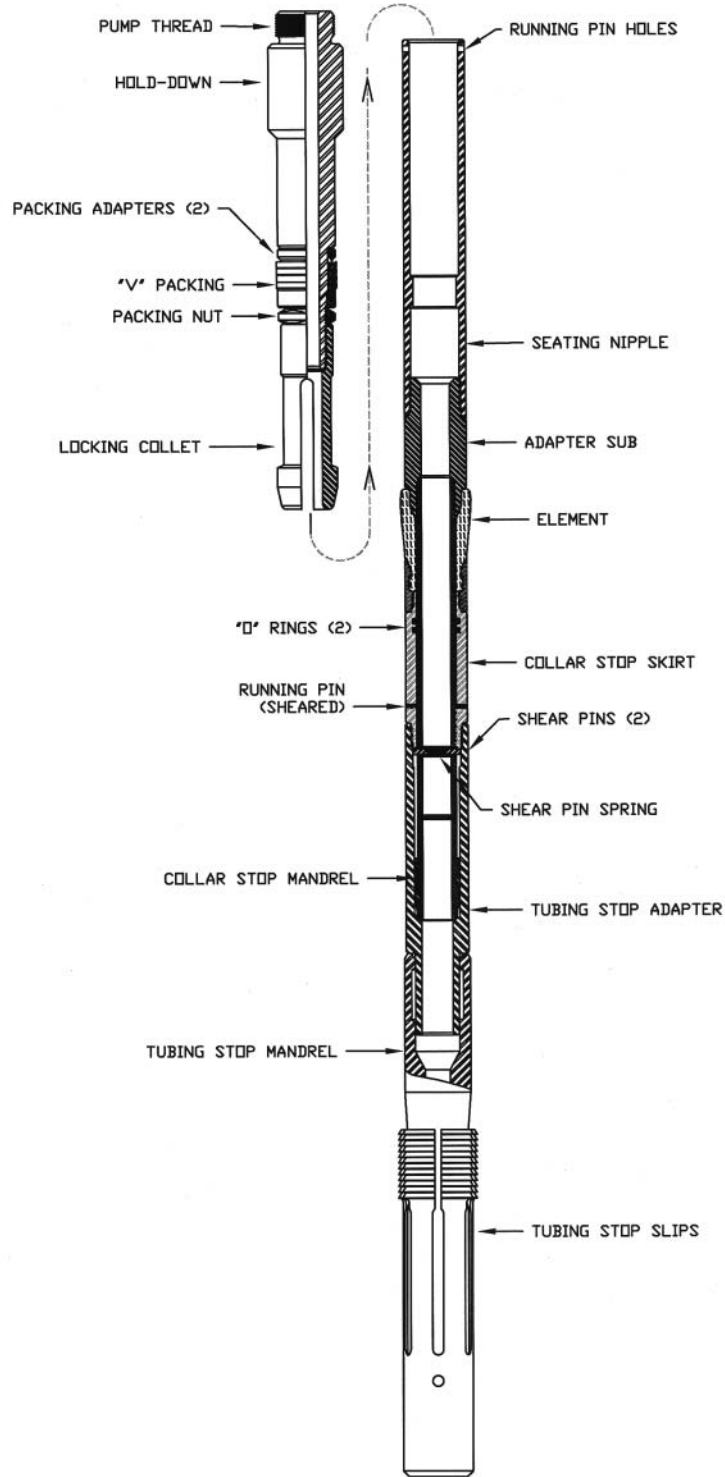

C.A.T. Tubing Stop

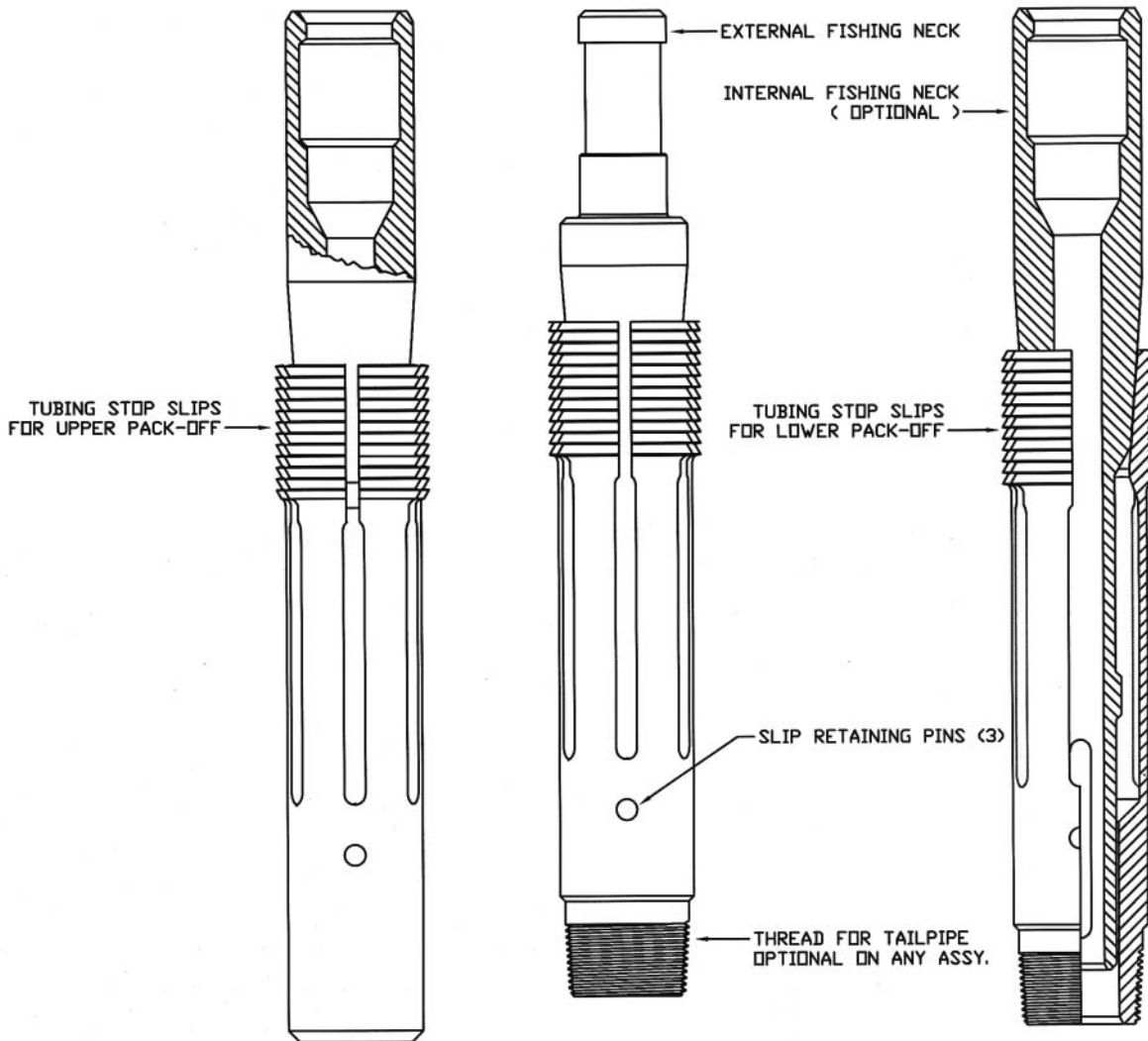

Templeton Test Plug with Equalizing Assembly (for T&C Tubing)

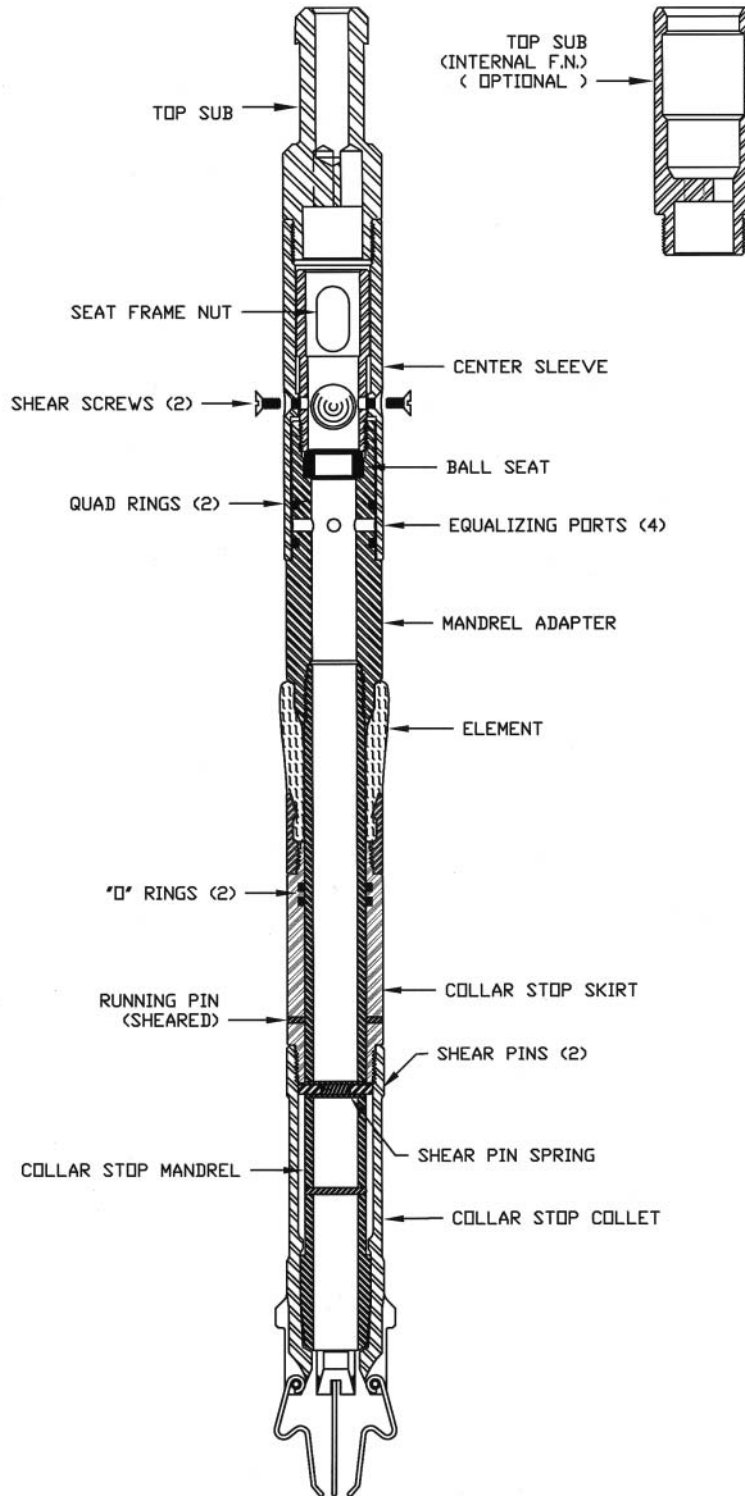

Templeton Locator Assembly with Equalizing Assembly (for T&C Tubing)

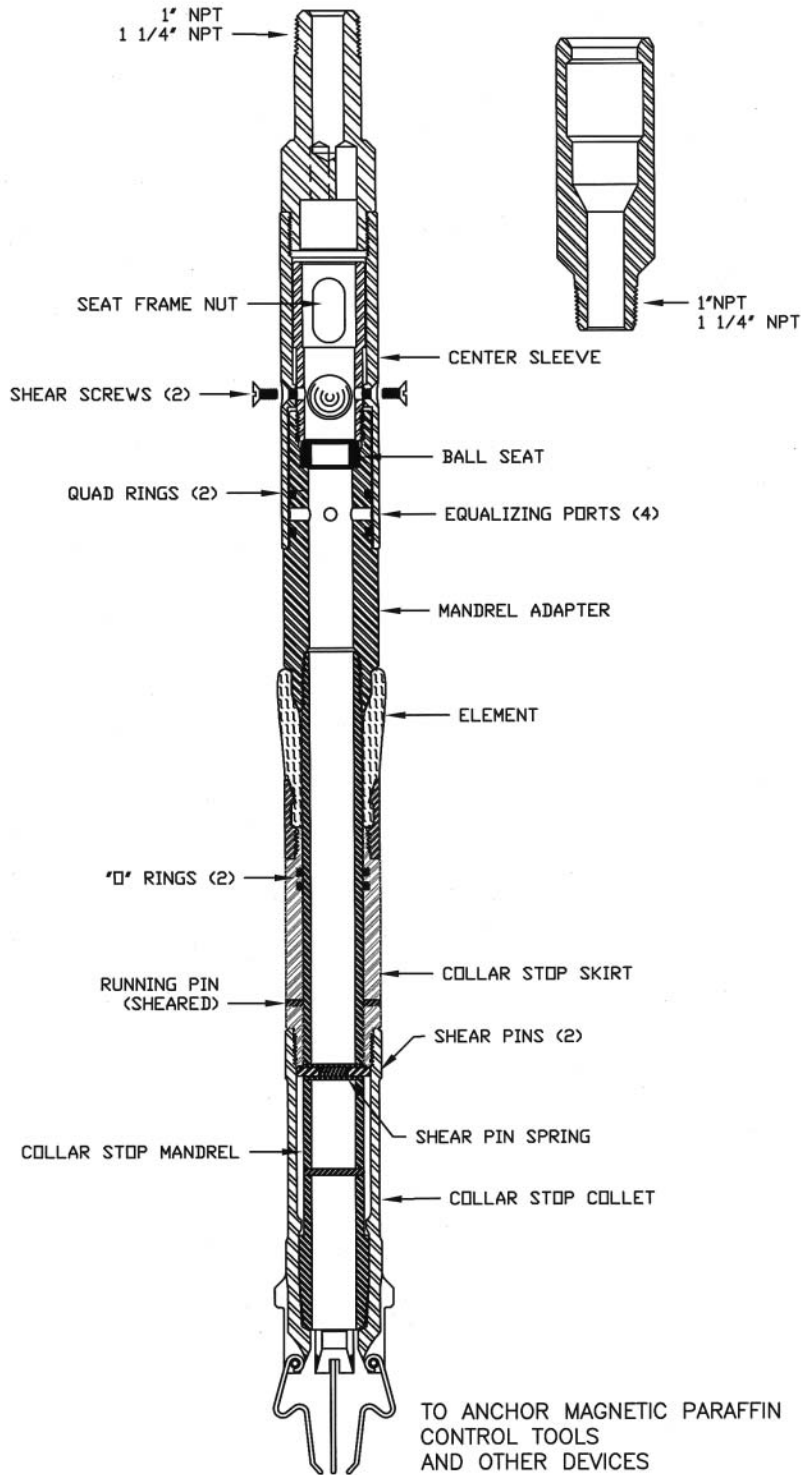

Templeton Locator Assembly (for T&C Tubing)

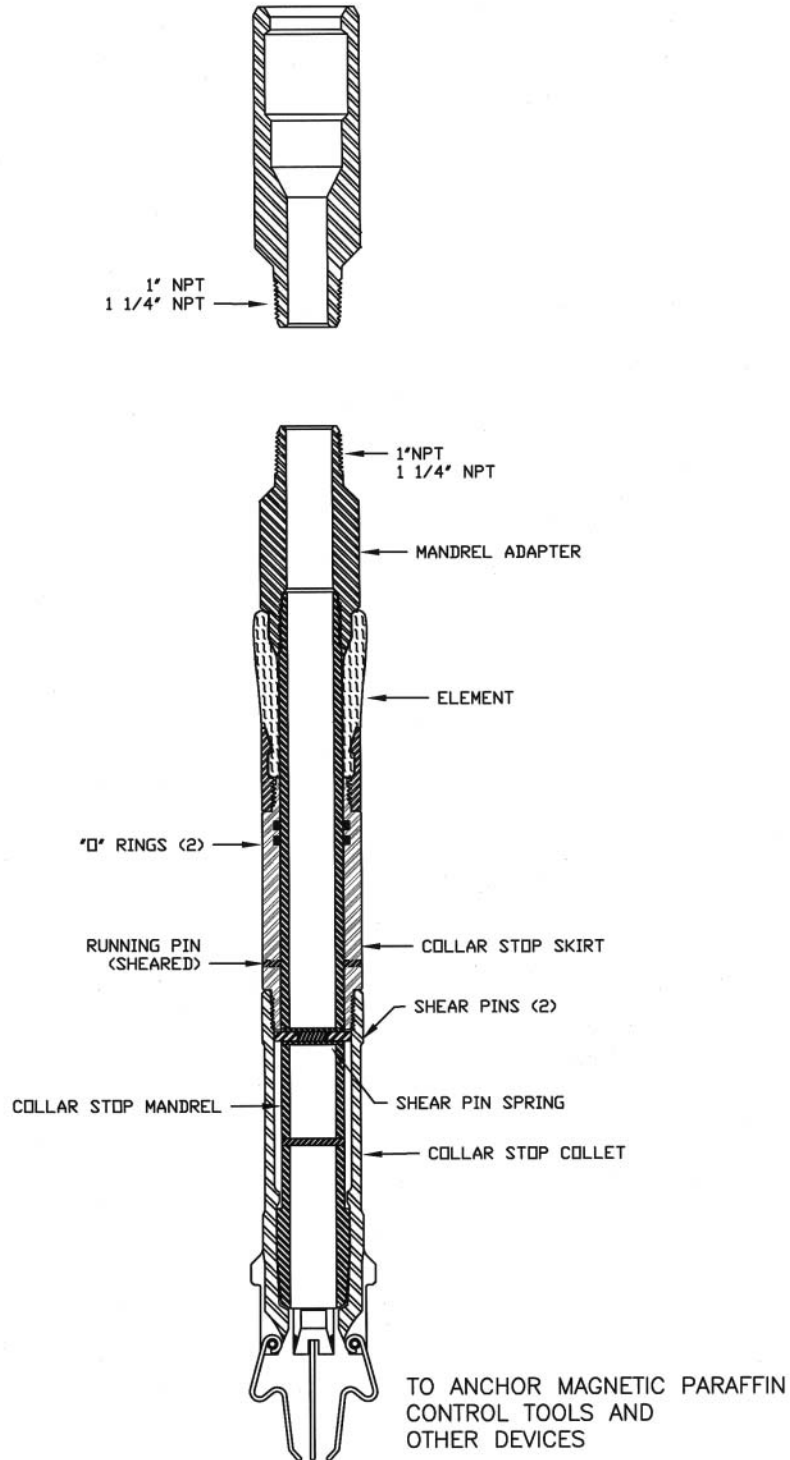

Templeton Locator Assembly (for IJ Tubing)

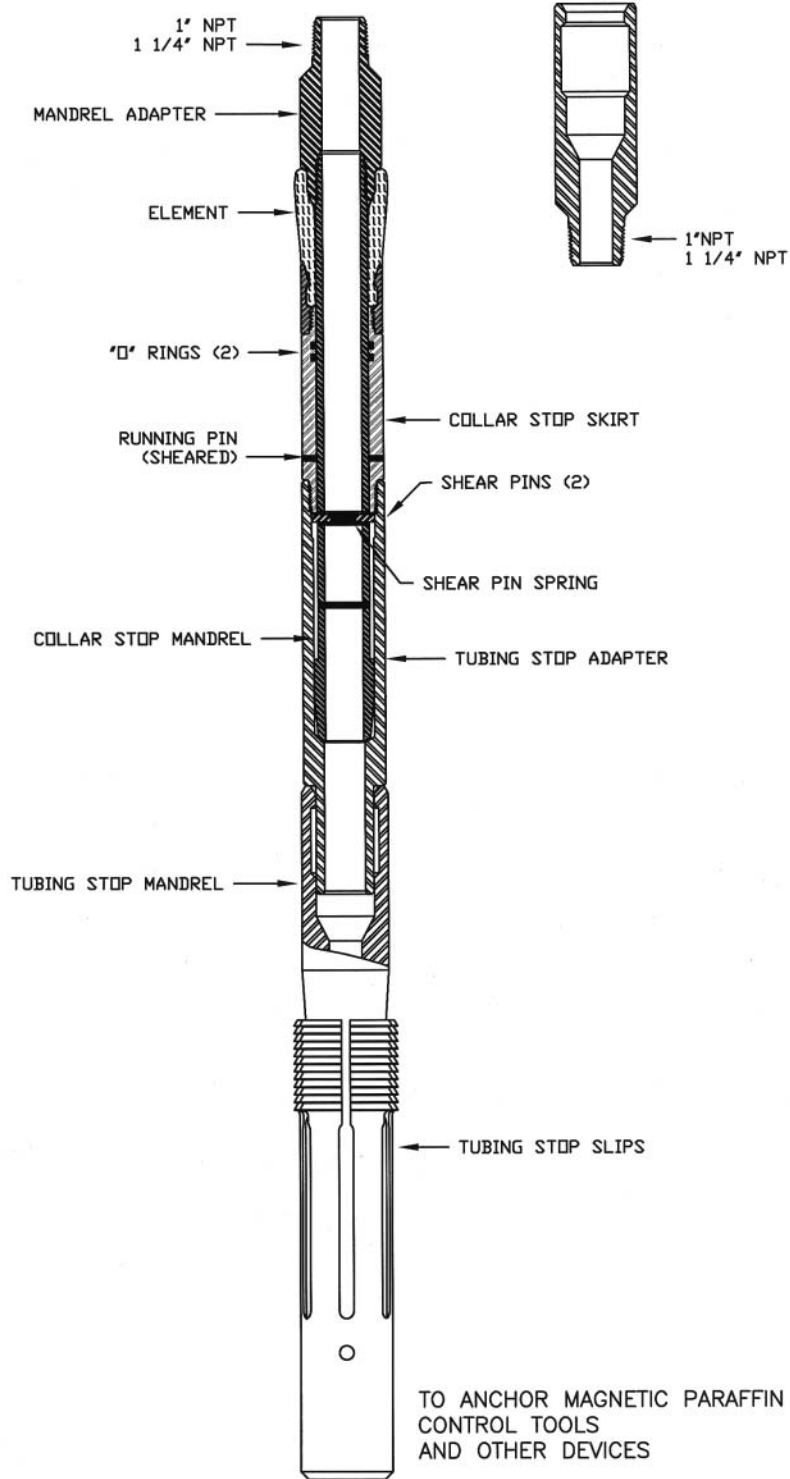

Templeton Locator Assembly (for IJ Tubing)

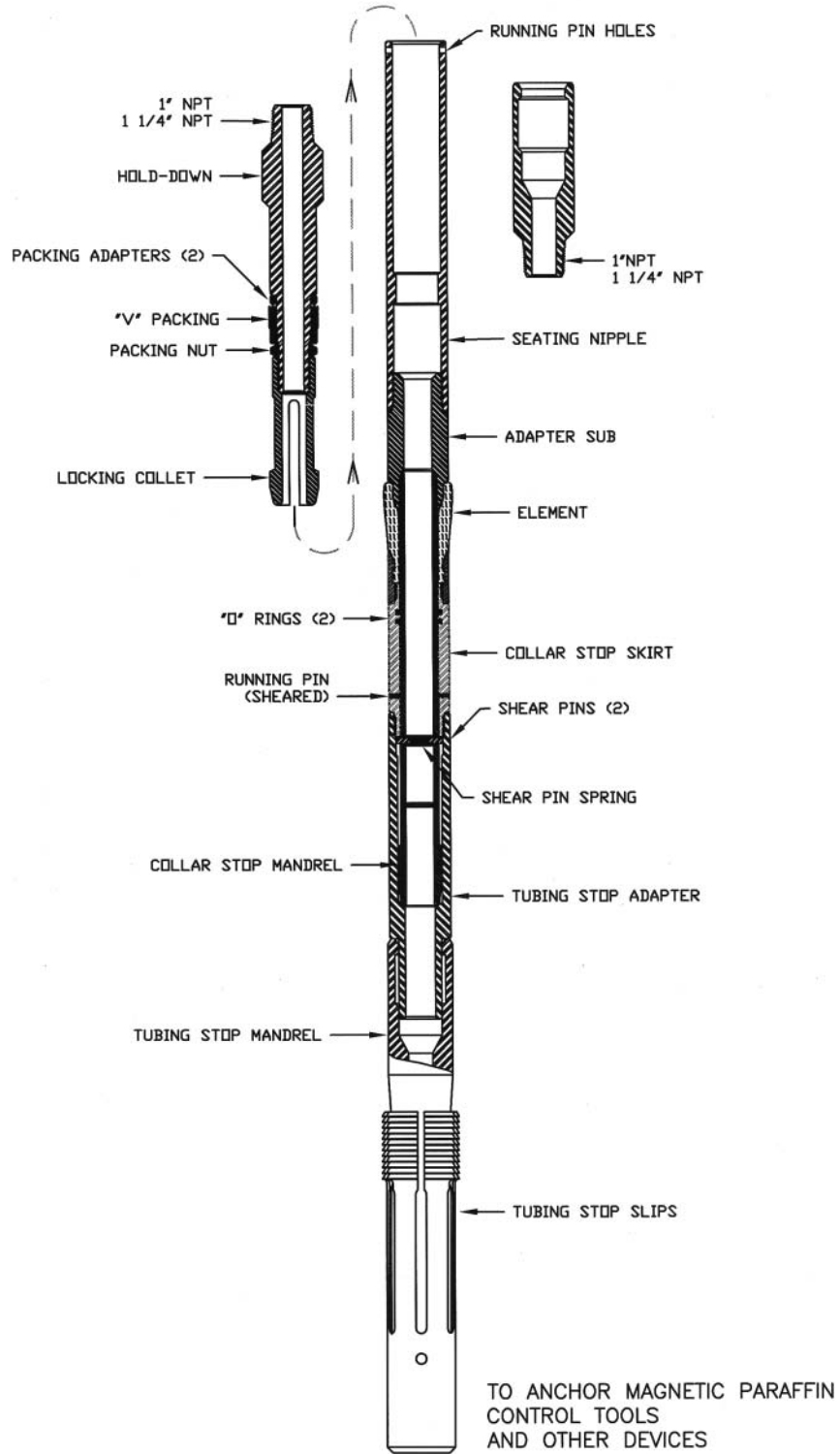

Templeton Test Plug with Equalizing Assembly (for Seating Nipples)

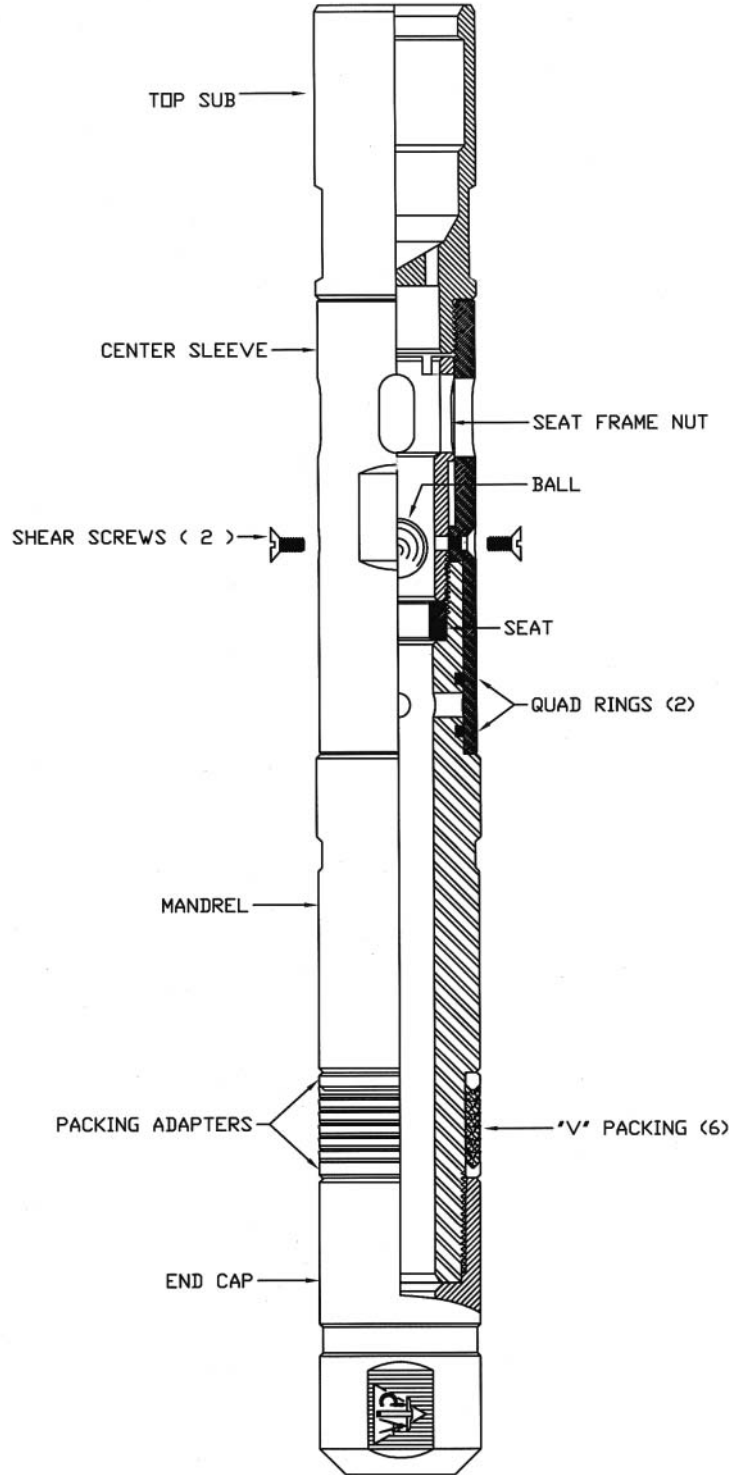

Segmented Pineapple Tubing Broaches

Pineapple Descaler Broach

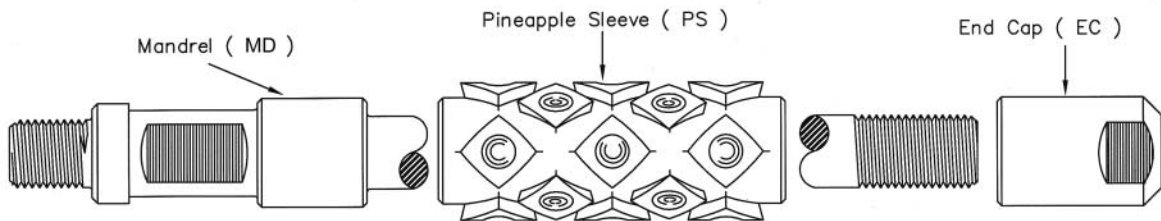

Pineapple Swaging Broach

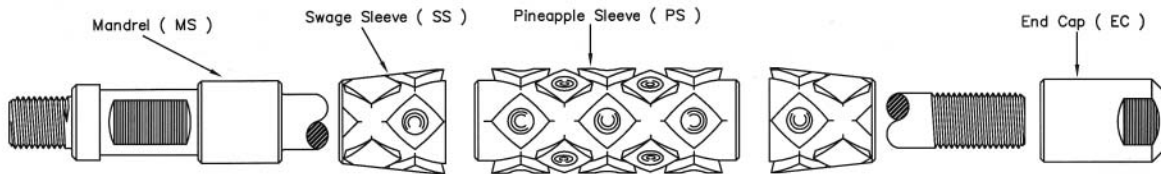

Pineapple Swaging Broach (Long Style)

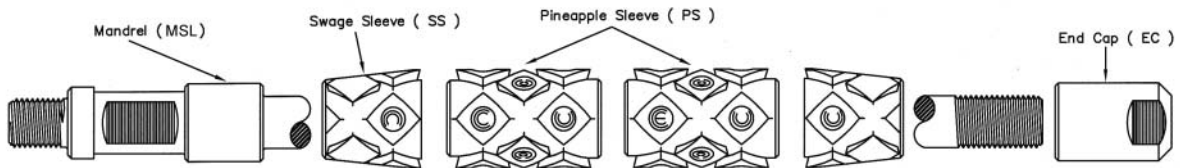

Note: Broach sleeve segments are finish ground to user size per order.

Pineapple Descaler Broach

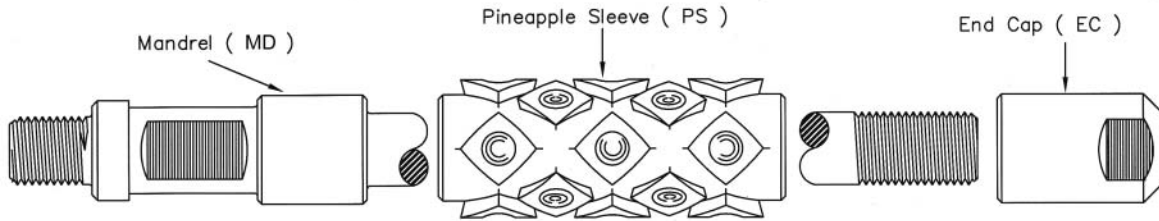

Size	Mandrel					Pineapple Sleeve		End Cap	Complete Assembly
	Part No.	Dia.	Length	Pin Size	E.N. Size	Part No.	Length	Part No.	Part No.
1.25-1.70	MD100	5/8	9 15/16	5/8-11	7/8	PS100	4 1/4	EC100	DA100
	MD101	5/8	9 15/16	5/8-11	1	PS100	4/14	EC101	DA101
	MD102	5/8	10 1/4	3/4-10	1	PS100	4/14	EC101	DA102
	MD103	5/8	10 1/4	15/16-10	1 3/16	PS100	4/14	EC101	DA103
1.70-2.00	MD200	1	11 3/4	15/16-10	1 3/8	PS200	4 3/4	EC200	DA200
	MD201	1	15 3/8	1 1/16-10	1 3/8	PS200	4 3/4	EC200	DA201
2.00-2.375	MD300	1 1/8	13	15/16-10	1 3/8	PS300	5 7/8	EC300	DA300
	MD301	1 1/8	13	1 1/16-10	1 3/8	PS300	5 7/8	EC300	DA301
2.40-2.50	MD400	1 1/8	13 1/2	1 1/16-10	1 3/8	PS400	5 7/8	EC400	DA400
2.50-2.68	MD500	1 1/8	14	1 1/16-10	1 3/4	PS500	6 3/8	EC500	DA500
2.68-2.74	MD600	1 1/8	14 1/2	1 1/16-10	1 3/4	PS600	6 5/8	EC600	DA600
2.74-2.80	MD700	1 1/8	14 1/2	1 1/16-10	1 3/4	PS700	6 5/8	EC700	DA700
2.80-3.00	MD800	1 1/8	15	1 1/16-10	1 3/4	PS800	7 1/8	EC800	DA800
3.00-3.30	MD900	1 1/8	15 7/8	1 1/16-10	1 3/4	PS900	8	EC900	DA900
3.30-3.53	MD1000	1 1/8	15 7/8	1 1/16-10	1 3/4	PS1000	8	EC1000	DA1000
3.53-3.61	MD1100	1 1/8	16 1/4	1 1/16-10	1 3/4	PS1100	8 3/8	EC1100	DA1100
3.61-3.74	MD1200	1 1/8	16 7/8	1 1/16-10	1 3/4	PS1200	9	EC1200	DA1200
3.74-3.80	MD1300	1 1/8	16 7/8	1 1/16-10	1 3/4	PS1300	9	EC1300	DA1300
3.80-3.90	MD1400	1 1/8	17 1/4	1 1/16-10	1 3/4	PS1400	9 3/8	EC1400	DA1400
3.90-4.00	MD1500	1 1/8	17 1/2	1 1/16-10	1 3/4	PS1500	9 5/8	EC1500	DA1500

Pineapple Swaging Broach

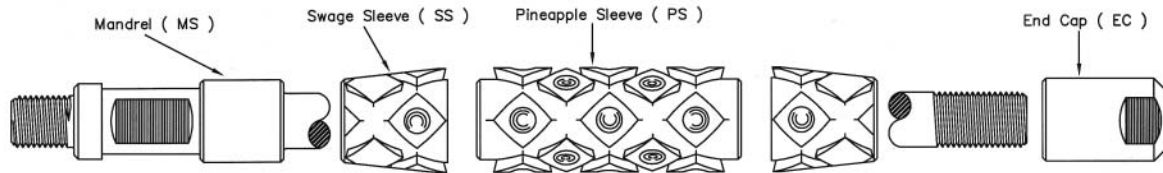

Size	Mandrel					Pineapple Sleeve		Swage Sleeve-2		End Cap		Complete Assembly
	Part No.	Dia.	Length	Pin Size	F.N. Size	Part No.	Length	Part No.	Length	Part No.	Part No.	
1.25-1.70	MS100	5/8	12 15/16	5/8-11	7/8	PS100	4 1/4	SS100	1 1/2	EC100	SA100	
	MS101	5/8	12 15/16	5/8-11	1	PS100	4 1/4	SS100	1 1/2	EC101	SA101	
	MS102	5/8	13 1/4	3/4-10	1	PS100	4 1/4	SS100	1 1/2	EC101	SA102	
	MS103	5/8	13 1/4	15/16-10	1 3/16	PS100	4 1/4	SS100	1 1/2	EC101	SA103	
1.70-2.00	MS200	1	15 3/8	15/16-10	1 3/8	PS200	4 3/4	SS200	1 7/8	EC200	SA200	
	MS201	1	15 3/8	1 1/16-10	1 3/8	PS200	4 3/4	SS200	1 7/8	EC200	SA201	
2.00-2.375	MS300	1 1/8	17 1/2	15/16-10	1 3/8	PS300	5 7/8	SS300	2 1/4	EC300	SA300	
	MS301	1 1/8	17 1/2	1 1/16-10	1 3/8	PS300	5 7/8	SS300	2 1/4	EC300	SA301	
2.40-2.50	MS400	1 1/8	18	1 1/16-10	1 3/4	PS400	5 7/8	SS300	2 1/4	EC400	SA400	
2.50-2.68	MS500	1 1/8	19 1/2	1 1/16-10	1 3/4	PS500	6 3/8	SS400	2 3/4	EC500	SA500	
2.68-2.74	MS600	1 1/8	20	1 1/16-10	1 3/4	PS600	6 5/8	SS400	2 3/4	EC600	SA600	
2.74-2.80	MS700	1 1/8	20	1 1/16-10	1 3/4	PS700	6 5/8	SS400	2 3/4	EC700	SA700	
2.80-3.00	MS800	1 1/8	21 1/2	1 1/16-10	1 3/4	PS800	7 1/8	SS500	3 1/4	EC800	SA800	
3.00-3.30	MS900	1 1/8	22 3/8	1 1/16-10	1 3/4	PS900	8	SS500	3 1/4	EC900	SA900	
3.30-3.53	MS1000	1 1/8	22 3/8	1 1/16-10	1 3/4	PS1000	8	SS500	3 1/4	EC1000	SA1000	
3.53-3.61	MS1100	1 1/8	23 1/8	1 1/16-10	1 3/4	PS1100	8 3/8	SS600	3 1/4	EC1100	SA1100	
3.61-3.74	MS1200	1 1/8	23 3/4	1 1/16-10	1 3/4	PS1200	9	SS600	3 1/4	EC1200	SA1200	
3.74-3.80	MS1300	1 1/8	23 3/4	1 1/16-10	1 3/4	PS1300	9	SS600	3 1/4	EC1300	SA1300	
3.80-3.90	MS1400	1 1/8	24 3/4	1 1/16-10	1 3/4	PS1400	9 3/8	SS700	3 3/4	EC1400	SA1400	
3.90-4.00	MS1500	1 1/8	25	1 1/16-10	1 3/4	PS1500	9 5/8	SS700	3 3/4	EC1500	SA1500	

Pineapple Swaging Broach (Long Style)

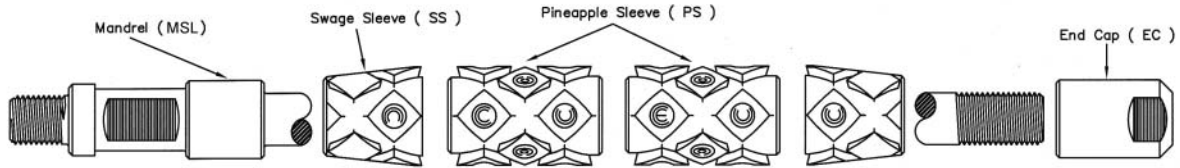

Size	Mandrel					Pineapple Sleeve		Swage Sleeve-2		End Cap	Complete Assembly
	Part No.	Dia.	Length	Pin Size	F.N. Size	Part No.	Length	Part No.	Length	Part No.	Part No.
1.25-1.70	MSL100	5/8	17 3/16	5/8-11	7/8	PS100	4 1/4	SS100	1 1/2	EC100	SLA100
	MSL101	5/8	17 3/16	5/8-11	1	PS100	4 1/4	SS100	1 1/2	EC100	SLA101
	MSL102	5/8	17 1/2	3/4-10	1	PS100	4 1/4	SS100	1 1/2	EC101	SLA102
	MSL103	5/8	17 1/2	15/16-10	1 3/16	PS100	4 1/4	SS100	1 1/2	EC101	SLA103
1.70-2.00	MSL200	1	16 5/8	15/16-10	1 3/8	PS250	3	SS200	1 7/8	EC200	SLA200
	MSL201	1	16 5/8	1 1/16-10	1 3/8	PS250	3	SS200	1 7/8	EC200	SLA201
2.00-2.375	MSL300	1 1/8	19	15/16-10	1 3/8	PS350	3 3/4	SS300	2 1/4	EC300	SLA300
	MSL301	1 1/8	19	1 1/16-10	1 3/8	PS350	3 3/4	SS300	2 1/4	EC300	SLA301

Plunger Pulling Tool

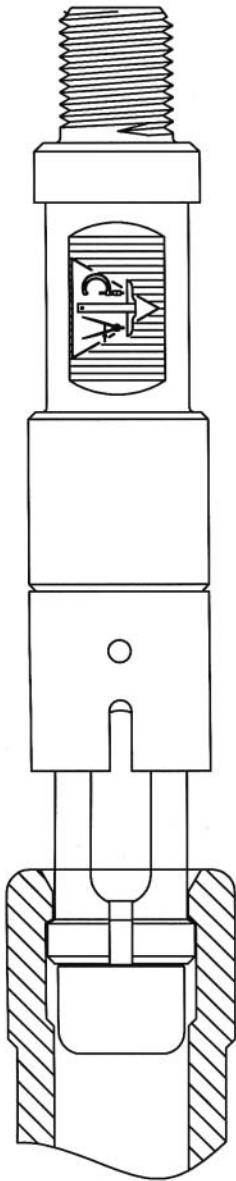

Plunger Pulling Tool
(Pulling Position)

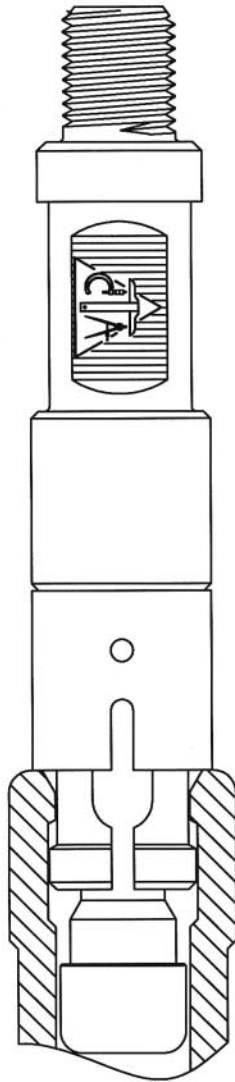

Plunger Pulling Tool
(Running Position)

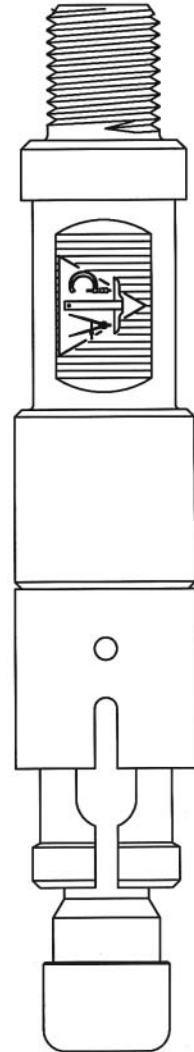

Plunger Pulling Tool
(Running Position)